

LD83



High Power 3 Cluster LED spotlight with Mounting Systems

Data sheet - Page 1

The LD83 is a high power, 3 cluster, adjustable LED spotlight. It features a wide range of mounting options and is suitable for a huge variety of applications. Each mounting method is custom made to each projects requirements, allowing the designer to tailor the lighting layout for each display. The best method of specification for these spotlights and mounting systems is to send us a sketch of what is required. This can then be discussed and we will produce a project specification and quote.

Key Features

- Utilizes the latest LED technology with a typical CRI of 93 in warm white
- Broad range of uses including display, picture and sign lighting
- Increased airflow & thermal efficiency
- Knuckle joint allows great flexibility in adjustment
- Custom made to suit exact specified dimensions
- Range of mounting options
- Precise beam control with a range of lenses
- Available with Switch, 0-10V, DMX, Dali or Mains dimmable drivers

Specification

Applications



Beam Angles

22°, 30°, 40°

LED type

3 x Cree XPG2

Colour temperature

2700K** / 3000K 5000K

	350	500	350	500
Drive Current (mA)	350	500	350	500
LED power* (W)	3.6	5.1	3.6	5.1
CRI (typical)	93	93	75	75
Forward voltage (V) ₁₀₀	9.0V	9.6V	9.0V	9.6V
Delivered lumens** (L ₁₀₀)	262	357	318	434
Lumens per circuit watt	77	71	94	87

LED lifetime (to 70% lumen maintenance) 50,000hrs at a max ambient temperature of 35°C (if specifying fitting in ambient temperatures of up to 45°C run at 350mA max, LD83-350)

Materials

Anodised aluminium body

Wiring

Comes pre-wired with either a 2 core or 4 core 120mm lead, can be specified with up to 10m at extra cost

Glass

1.2mm thick borofloat

IP rating

IP40

*LED wattage includes losses associated with using an 85% efficient driver

**2700K lumen output is 12% lower than the 3000K figure listed

4000K lumen output is 14% higher than the 3000K figure listed (80 CRI)



LD83 on PL-1 Fixing plate

LD83 is supplied as standard with a knuckle joint. This is then fixed to a range of mounting options

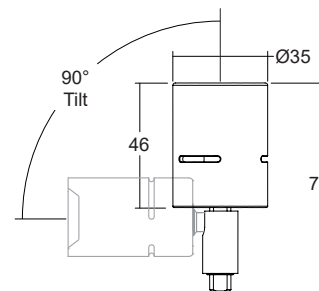

LD83



High Power 3 Cluster LED spotlight with Mounting Systems

Data sheet - Page 2

Mounting Options and Dimensions

Stem Mounting Methods - This 2 part aluminium profile has been designed as a slight oval and is counterbored where the knuckles attach which gives a slim look and neat detail at the junction. The best method of specification is to send us a sketch of what is required, this can then be discussed and a project quote created. 3 mounting methods are available and each is custom made to the specification.

/M1

Method 1 - for fixing to the base of a cabinet, with cables exiting from the M8 all-thread stud. Specify stem length, number of spotlights and spacing.

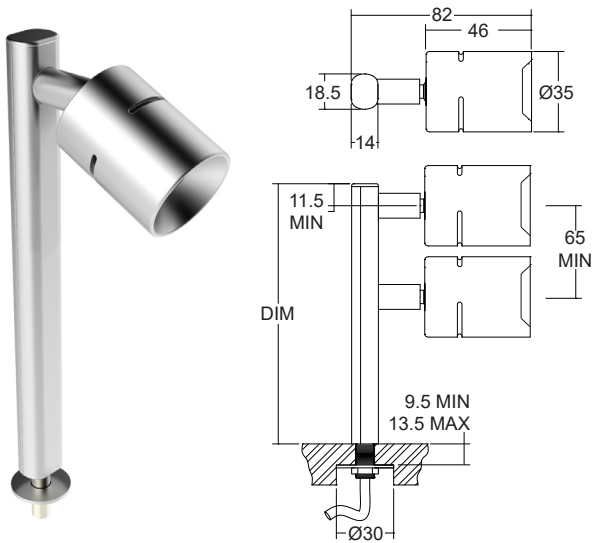

/M2

Method 2 - surface mounted option with cable exit at the back. Specify stem length, number of spotlights and spacing.

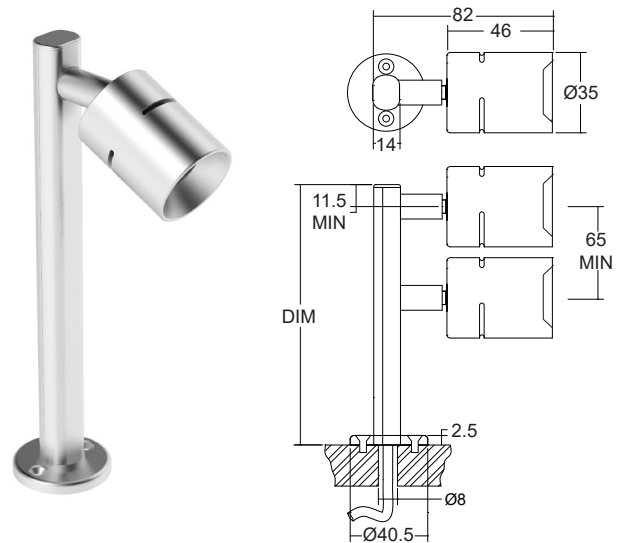

/M3

Method 3 - stem is fixed at the bottom with a surface mount base and screws. An M8 thread and nut is used to fix at the top. Specify stem length, number of spotlights and spacing.

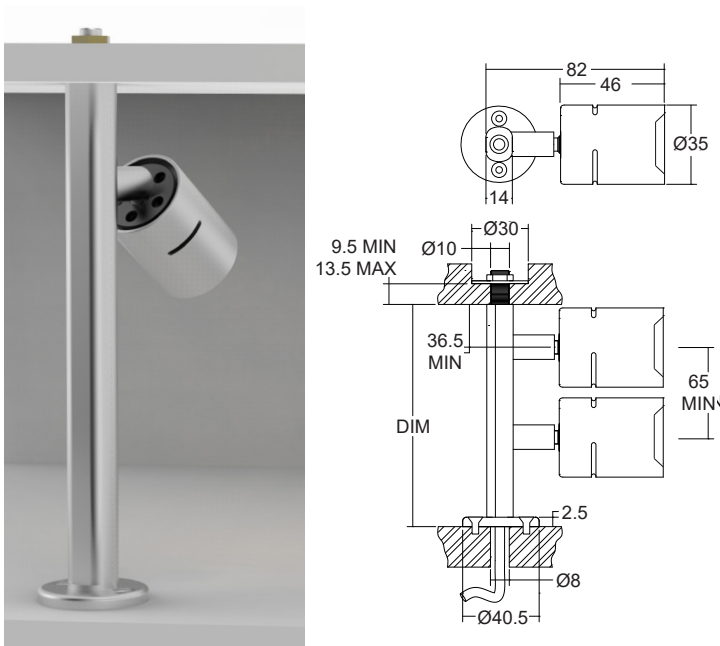

LD83

High Power 3 Cluster LED spotlight with Mounting Systems



Data sheet - Page 3

/PL1

Single swivel mounting plate is very useful for mounting individual spotlights neatly into the sides, top or base of cabinets.

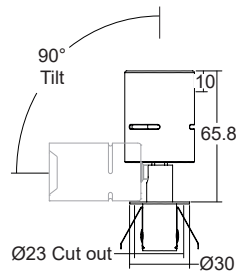

/E1313

Aluminium U channel can be flush mounted into a routed groove into the side of cabinets which makes a very neat detail. All the wiring can be done at the manufacturing stage speeding up installation. Specify length, number of spotlights and spacing.

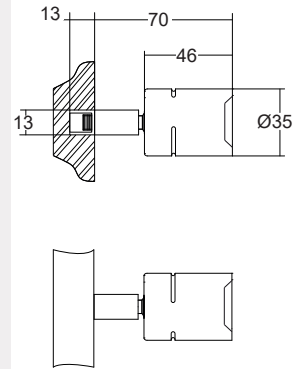

/SMB82

Surface mount base

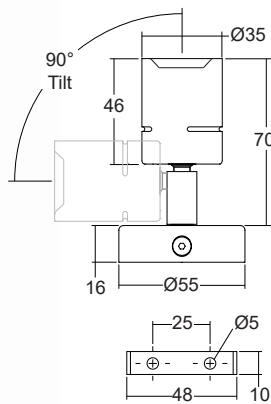

/CP-1

Single LD83 mounted on ceiling plate. Easy to install with constant force springs. Ideal for ceiling applications. Hole cut out big enough for a driver.

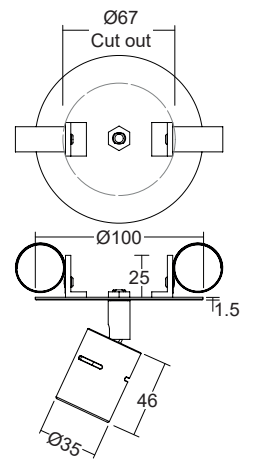

LD83

High Power 3 Cluster LED spotlight with Mounting Systems



Data sheet - Page 4

/CP-2

2x LD83 mounted on a ceiling plate. Easy to install with constant force springs. Ideal for ceiling applications. Hole cut out big enough for driver.

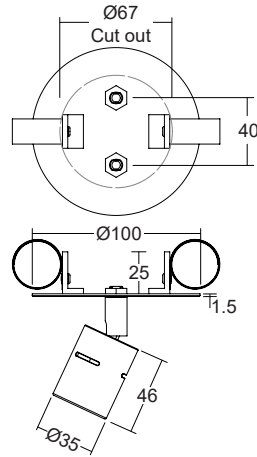

Photometrics

Photometric files are included in the design pack which can be downloaded from the LD83 product page on the website.

Order Codes and Options

Product code	LED colour	Lens angle	Finish	Mounting method	Length
LD83 - 350 - 500	<input type="text"/>	<input type="text"/>	<input type="text"/>	<input type="text"/>	<input type="text"/>

Example: LD83-500 / LW30 / MB / IP40 / E1313 / Black

Product codes with output options

3.6W LED at 350mA	LD83-350
5.1W LED at 500mA	LD83-500

LED colour options

Super Warm White (2200K)	/LW22
Extra Warm White (2700K)	/LW27
Warm White (3000K)	/LW30
White (4000K) - on request	/LW40
Cool White	/LW50
Optional secondary red circuit (See sales for more information)	/LW** + LR
Blue	/LB
Green	/LG
Red	/LR
Amber	/LA

*Other LED colour temperatures are available. Please speak to a member of our sales team.

Beam / lens angle options

22° narrow spot	/NB
30° medium	/MB
40° wide	/WB

Mounting Methods

Method One	/M1
Method Two	/M2
Method Three	/M3
'U' Channel	/E1313
Swivel Plate Mounting	/PL1
Surface Mount Base	/SMB
Single Ceiling Plate	/CP-1
Dual Ceiling Plate	/CP-2

Finish options

Paint finish silver / black / white (RAL 9016) / antique bronze / satin antique brass / satin brass / RAL finish

LED Drivers

Use with 350mA or 500mA constant current LED drivers.

We have a wide range of dimmable LED drivers, 0-10V, DMX, DALI and Mains dimmable. Please see the downloads section on our website:

To run 1-4 LD83-350 in series use a TXDEL350D (0-10V dimmable)

To run 1-4 LD83-500 in series use a TXDEL500D (0-10V dimmable)